

Article number: 3918049018233

Description: Worm gear with st. steel hollow shaft
VF 49 EP-A-18- 80B14

Measures

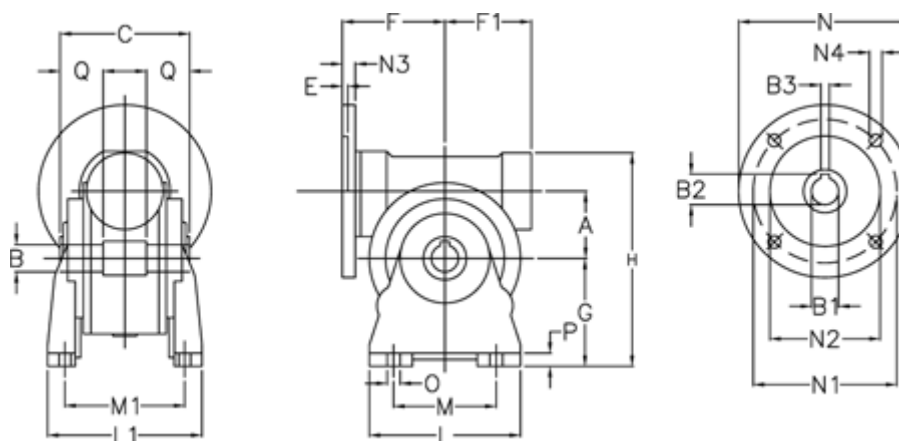

a	= 49.5	F1	= 63	N1	= 100
B	= 25	g	= 82	N2	= 80
B1 E7	= 19	H	= 162	N3	= 10.0
B2	= 21.8	L	= 110	N4	= 7.0
B3 H9	= 6	L1	= 124.0	O	= 8.5
C	= 82	m	= 63	P	= 12
E	= 3.0	M1	= 98.5	Q	= 22.5
F	= 70	N	= 120		